



STRUCTURE PARTS



STRUCTURE PARTS

INTRODUCTION

The glass plant and equipments are supported in a rectangular tubular structure. This tubular structure consists of galvanized mild steel tubing with cast iron fittings, which is described in this catalogue. This type of structure provides enough flexibility for future modifications and is strong enough to support a glass plant.

S.S powder coated tubings and structure parts can also be supplied on request basis.

TUBE SIZE

Since there are various terminologies in common use to determine tube sizes, the following table is given to compare and relate them to the fitting size reference.

TUBE DIAMETER IN INCHES	NOMINAL BORE IN MM	EXTERNAL DIAMETER IN MM
3/4"	19	21.5
1"	25	32.5
1 1/4"	30	41.5
1 1/2"	40	48.3
2"	50	60.3

SUPPORTING COLUMN

In the design of tubular steel structure to support glass process plant and pipeline equipment, a number of basic rules should be followed.

- ☞ The structure should be stiff and should always be braced back to the nearest building or other stiff feature to give lateral support.
- ☞ All glass units are built up from a fixed point on which whole weight of the column should be taken. If a total load exceeds the allowable limits, counter balance supports should be used to relieve excessive weight.
- ☞ All Glass units and their structures expand at different rates as a result of change in temperature. The unit must, therefore not be subjected to any vertical restraint above the fixed point. Due to this, guides are used which give lateral support without affecting vertical movement of the glass, relative to the supporting structure. The distance between guide frames must not exceed 3meters.
- ☞ The whole weight of a column must be taken up from the fixed point. This normally presents no problem up to DN 300, but with larger columns it may be necessary to take up some of the weight by means of counterbalance supports.

STRUCTURE FITTINGS

Following structure fittings are available to use with galvanized iron tubes in order to form a tubular structure of a glass plant.

- ☞ These fittings are made of cast iron and are suitable to the galvanized tubes described earlier.
- ☞ These sliding are provided with grub screws to fix it at required position on galvanized tube.
- ☞ These fittings are specially made to construct a tubular structure, which provides enough flexibility for future modifications without involving any hammering and welding.

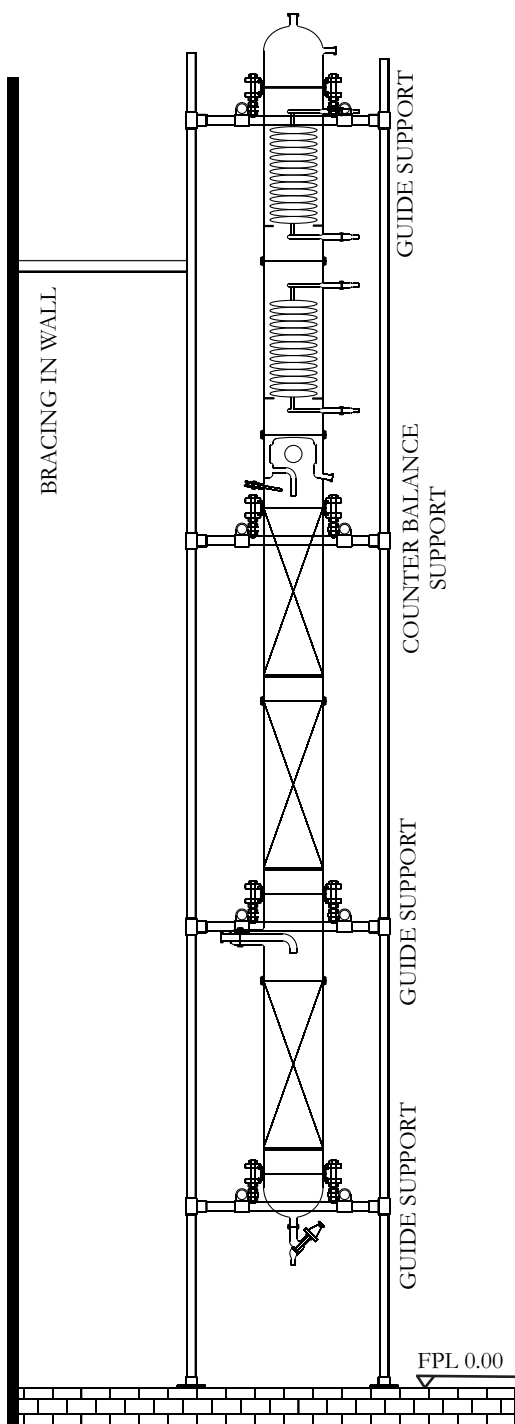

Since there are various terminologies in common use to determine tube sizes, the following table is given to compare and relate them to the fitting size reference.

BASE	NB	CAT. REF.
These are to be used in, with vertical pipes. Holes are provided for foundation.	25	ABS 25
	30	ABS 30
	40	ABS 40
	50	ABS 50

BEND	NB	CAT. REF.
These are used to build frames on vertical pipes.	25	ABN 25
	30	ABN 30
	40	ABN 40
	50	ABN 50

DOUBLE BEND	NB	CAT. REF.
These are used to extend frames on horizontal pipes.	25	ADB 25
	30	ADB 30
	40	ADB 40
	50	ADB 50

TEE	NB	CAT. REF.
	25	AT 25
	30	AT 30
	40	AT 40
	50	AT 50

DOUBLE TEE	NB	CAT. REF.
	25	ADT 25
	30	ADT 30
	40	ADT 40
	50	ADT 50

CROSS	NB	CAT. REF.
	25	AX 25
	30	AX 30
	40	AX 40
	50	AX 50

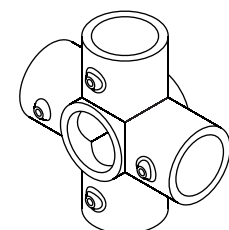
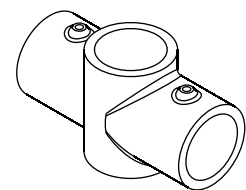
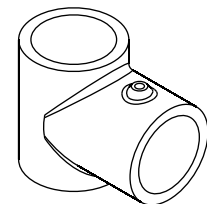
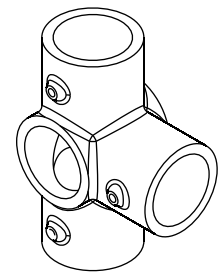
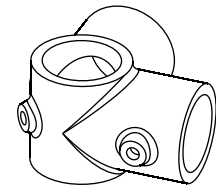
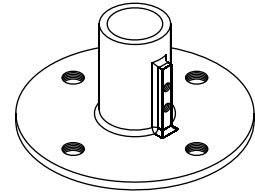

STRUCTURE PARTS

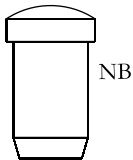
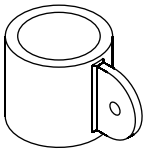
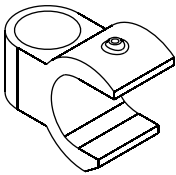
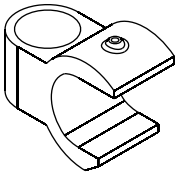
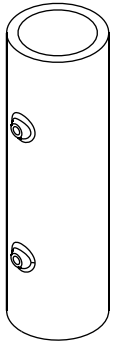

COUPLER	NB	CAT. REF.
These are used to couple the vertical pipes where more length is required	25	ACL 25
	30	ACL 30
	40	ACL 40
	50	ACL 50

EQUAL BRACKET	NB	CAT. REF.
	25	AEBT 25
	30	AEBT 30
	40	AEBT 40
	50	AEBT 50

UNEQUAL BRACKET	NB	CAT. REF.
	25	AUBT 25/15
	30	AUBT 30/25
	40	AUBT 40/25
	50	AUBT 50/25

SUPPORT	NB	CAT. REF.
	15	ASPT 15
	25	ASPT 25
	30	ASPT 30
	40	ASPT 40
	50	ASPT 50

PLUG	NB	CAT. REF.
These are used to plug the open ends of galvanized tubes.	25	APL 25
	30	APL 30
	40	APL 40
	50	APL 50

STUD	D	CAT. REF.
	5/16"	AST 5/16
	3/8"	AST 3/8
	1/2"	AST 1/2

GROUTING OF BASE

- 1.** Take one cast iron base and four foundation bolts, each with 2 nuts.
- 2.** Fit bolts in the base so that the base is raised up to 150 mm from head of bolts.
- 3.** Put this assembly on the floor and prepare a rough surface for proper bonding of grouting.
- 4.** Make a concrete block over the bolts of about 200 x 200 mm up to the base of base i.e 150 mm high.
- 5.** Prepare separate block for each base instead of making one big common block for all bases.

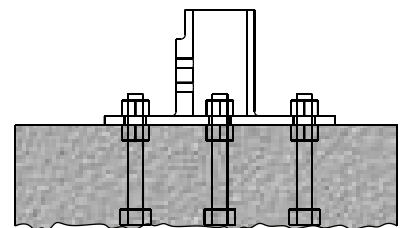
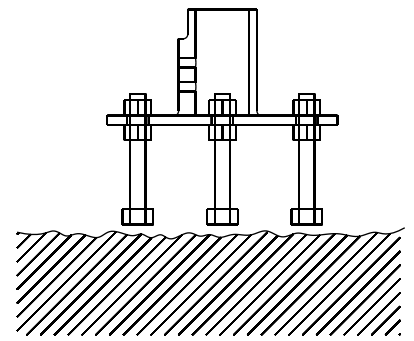
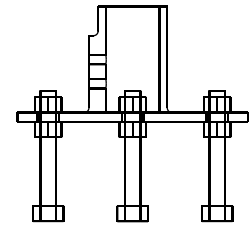
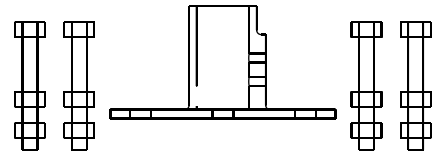

STRUCTURE PARTS

TUBULAR STRUCTURE ASSEMBLING

Structures are designed to support plant and other equipment comprising components exclusively or principally in borosilicate glass 3.3. Mostly these structures consist of steel/galvanized tubing in four different diameters, which is connected using the suitable fittings. As a result, the structures cannot only be dismantled and reassembled whenever required but they can also be modified and added to quite easily.

- A. Slide the fittings on to the tubes in correct sequence and lightly tighten in approximate position.
- B. Assemble one side frame of the structure by adding the cross tubes between two vertical tubes.
- C. Build up the cross tubes to form the ends of the structure.
- D. Add the remaining vertical tubes and cross tubes to complete the structure and tighten all the fittings.
- E. Hoist the structure and brace it to some existing rigid feature.
- F. Grout the foundation bolt and fix the structure bases with that.
- G. Adjust bracing to obtain a correct plum in structure.
- H. Adjust the horizontal frames at correct level.
- I. Assemble the support tubes at their positions.

